



New York State
Department of Motor Vehicles

**DRIVER'S MANUAL FOR THE
SAFE SECUREMENT
OF
METAL COILS
AND
OTHER CARGO**



INTRODUCTION

Chapter 63 of the Laws of 2002 amends Section 501(2)(b)(ix) of the NYS Vehicle and Traffic Law to require that any commercial driver who transports metal coils, which individually or bundled together weigh 5,000 lbs. or more, must have a metal coil endorsement on his/her New York Commercial Driver's License (CDL). Drivers from other states are not required to have this endorsement even if they are transporting metal coils through New York State.

You must hold a Class A, B or C license and pass a written knowledge test to qualify for the Metal Coil endorsement (it will be identified as the code "M" on the endorsement section of your license). The written test is based on the material presented in this manual. Cargo securement terms are italicized throughout the manual and are defined on pages 4.1 and 4.2. At the test site, you will be given a copy of the Working Load Limit Table (see page 2.7) to use in answering some of the test questions.

If you do not already have a CDL, you will have to take the CDL Core Test as well as the Metal Coil knowledge test. You will also have to pass a skills test in a vehicle that is appropriate for the type of license for which you are applying.

- If you are applying for a CDL Class C license, you will have to pass a skills test in a vehicle weighing more than 18,000 lbs., but less than 26,000 lbs.
- To obtain a CDL Class B license, you will have to pass a skills test in a vehicle weighing more than 26,000 lbs.
- If you are applying for a Class A license to operate a tractor-trailer or truck-trailer type vehicle (and the trailer weighs more than 10,000 lbs.), you must pass a skills test in a combination vehicle.

For other endorsements, please refer to the following Driver License Class Descriptions:

DRIVER LICENSE CLASS DESCRIPTIONS

License Class / (Minimum Age)	Vehicle Type Examples	Vehicle Descriptions	Endorsement & Codes	Restrictions & Codes
A (21)	Combination — such as tractor-trailer or truck- trailer	<ul style="list-style-type: none"> Gross combination weight rating (GCWR) of more than 26,000 lbs., provided the gross vehicle weight rating (GVWR) or GCWR of vehicle(s) being towed is more than 10,000 lbs. 	<ul style="list-style-type: none"> Tank (N) Hazardous Materials (H)*** Tank and HazMat (X)*** Double/Triple (T) Passenger (P) Metal Coil (M) Tow Truck (W)* School Bus (S) 	<ul style="list-style-type: none"> No interstate commerce (K) Not valid for air brakes (L) Not valid for Class A air brakes (L1) Municipal or School operations only (A3) Ignition interlock device required (A4)***** <p>Truck/trailer Combination:</p> <ul style="list-style-type: none"> Truck/trailer combination only (O) Truck cannot exceed 26,000 lbs. GVWR (O1) <p>Passenger endorsement restrictions:</p> <ul style="list-style-type: none"> Class B vehicles (M) Class C vehicles (N) No vehicle designed for 15 or more adults (N1) No vehicle designed for 8 or more adults (N2)
B (21) (18 - No interstate commerce. Cannot transport hazardous materials or operate a school bus.)	Single — such as heavy single unit truck	<ul style="list-style-type: none"> GVWR of more than 26,000 lbs. (Class B may tow vehicles with a GVWR of 10,000 lbs. or less, or may tow a vehicle of more than 10,000 lbs. providing the GCWR is not more than 26,000 lbs.) 	<ul style="list-style-type: none"> Tank (N) Hazardous Materials (H)*** Tank and HazMat (X)*** Passenger (P) Metal Coil (M) Tow Truck (W)* School Bus (S) 	<ul style="list-style-type: none"> No interstate commerce (K) Not valid for air brakes (L) Not valid for Class B air brakes (L2) Municipal or School operations only (A3) Ignition interlock device required (A4)***** <p>Passenger endorsement restrictions:</p> <ul style="list-style-type: none"> Class C vehicles (N) No vehicle designed for 15 or more adults (N1) No vehicle designed for 8 or more adults (N2)
CDL C (21) (18 - No interstate commerce. Cannot transport hazardous materials or operate a school bus.)	Single — such as single unit truck or bus	<ul style="list-style-type: none"> GVWR of 26,000 lbs. or less that: - Transports 15 or more passengers; OR - Transports passengers under Article 19-A of the V & T Law, OR - Carries Hazardous Materials (Class C may tow vehicles with a GVWR of 10,000 lbs. or less, or may tow a vehicle of more than 10,000 lbs. providing the GCWR is not more than 26,000 lbs.) 	<ul style="list-style-type: none"> Tank (N) Hazardous Materials (H)*** Tank and HazMat (X)*** Passenger (P) Metal Coil (M) Tow Truck (W)* School Bus (S) 	<ul style="list-style-type: none"> No interstate Commerce (K) Not valid for air brakes (L) Municipal or School operations only (A3) Ignition interlock device required (A4)***** <p>Passenger endorsement restrictions:</p> <ul style="list-style-type: none"> No vehicle designed for 15 or more adults (N1) No vehicle designed for 8 or more adults (N2)

* Tow trucks with "S" endorsement valid until next DMV document is issued (e.g. renewal, duplicate), then converted to "W".

*** See HAZMAT Manual (CDL-11) for requirements.

***** The interlock device is not required in a motor vehicle owned by the licensee's employer if the vehicle is used in the course of the licensee's employment. The employer must consent to the use of the vehicle without the device.

TABLE OF CONTENTS

INTRODUCTION	i - ii
SECTION 1 — Fundamentals of Cargo Securement	1.1 - 1.5
Guiding Principle	1.1
Consequences for Drivers Who Do Not Follow the Standard	1.1
When to Apply the Standard	1.1
General Requirements of the Standard	1.1
Performance Criteria for Securement Systems	1.2 - 1.4
PART I - Cargo Securement Performance Criteria ...	1.2 - 1.4
Fully Contained Cargo	1.4
PART II - Components of a Securement System ...	1.4
TEST YOUR KNOWLEDGE	1.5
SECTION 2 — General Provisions and Requirements	2.1 - 2.18
Failure Modes for Securement Systems	2.1
Objectives for Securement Equipment and Devices ...	2.1 - 2.5
Category 1	
• Vehicle Structure and Anchor Points	2.2
• Cargo Securement Responsibility	2.2
• Cab Shields	2.2
Category 2	
• Securement Method	2.3
Category 3	
• Securement Devices, Assemblies and Components - Packaging	2.3
• Securement Devices, Assemblies and Components - Tiedowns	2.4
• Responsibility for Tightening Tiedowns	2.4
• Location of Tiedowns	2.5
• Use of Edge Protection	2.5
Category 4	
• Dunnage Materials	2.5

SECTION 2 (CON'T)

General Securement Requirements -
Securement Options. 2.6
Working Load Limit (WWL)/Table 2.6 - 2.7
Strength Rating for Blocking Systems 2.8
Securement System Strength Rating for Marked Components 2.9
Securement System Strength Rating for Unmarked Components 2.9
Cargo Placement and Restraint 2.10
Cargo Roll Prevention. 2.11
Aggregate Working Load Limit for Tiedowns 2.12
Purpose of Direct Tiedowns 2.13
Angles Required When Using Direct Tiedowns 2.13
Calculating Working Load Limits for Direct Tiedowns 2.14
Purpose of Indirect Tiedowns 2.14
Angles Required for Using Indirect Tiedowns 2.15
Calculating Working Load Limits for Indirect Tiedowns 2.16
Minimum Number of Indirect Tiedowns Required 2.16 - 2.17
Inspection of Securement Systems 2.17
TEST YOUR KNOWLEDGE 2.18

SECTION 3 — Metal Coils 3.1 - 3.8

Preventing Securement Failure 3.1
Application 3.1
Securement Requirements for a Single Metal Coil
With Eyes Vertical 3.2
Securement Requirements for a Row of Metal Coils
With Eyes Vertical 3.3
Securement Requirements for Metal Coils
With Eyes Crosswise 3.4 - 3.5
Securement Requirements for Individual Metal Coils
With Eyes Lengthwise 3.5 - 3.6
Securement Requirements for a Row of Metal Coils
With Eyes Lengthwise 3.7
Securement Requirements for Metal Coils in Sided Vehicles
or Intermodal Containers without Anchor Points 3.8
TEST YOUR KNOWLEDGE 3.9

DEFINITIONS 4.1 - 4.2

Cover photo courtesy of Riverside Services

SECTION 1

FUNDAMENTALS OF CARGO SECUREMENT

Guiding Principle:

Public safety requires that *METAL COILS* and other cargo being transported on the highway must remain on or within the vehicle under normal driving conditions. The purpose of the standard is:

- to make highways more safe
- to have less damage to cargo

Consequences for Drivers Who Do Not Follow the Standard:

- Delay of trip due to roadside enforcement activity
- Possible accident resulting in personal injury or death
- Financial losses to the driver and carrier, such as: loss of shipment, criminal or civil prosecution, increase in insurance rates, clean-up costs after the accident
- Damage to cargo

When to Apply the Standard:

Apply the standard when securing cargo to be transported on a highway by commercial vehicles:

- Cargo Type - for cargo and dangerous goods/hazardous materials, including equipment carried for vehicle operation and the contents of intermodal containers.
- Vehicle Type - for commercial vehicles (trucks, truck tractors, semi-trailers, full trailers and *tractor-pole trailers*) with a gross vehicle weight rating of more than 4,500 kgs. / 10,000 lbs.

General Requirements of the Standard:

Cargo must be contained or secured so it does not:

- leak
- spill
- blow
- fall from
- fall through
- become dislodged
- swing or shift, making the vehicle unstable

Performance Criteria for Securement Systems:

PART I - Cargo Securement Performance Criteria

The standard provides the minimum amount of force that cargo should be expected to withstand, in each direction, as shown below.

These minimum force requirements, called the “performance criteria”, were determined after extensive testing. The securement system **MUST** be capable of resisting these forces, as shown below.

- The forward force (80% of the cargo weight) represents braking while driving straight ahead.
- The rearward force (50% of the cargo weight) represents vehicle acceleration or braking in reverse.
- The side-to-side or lateral force (50% of the cargo weight) represents traveling on a curve, ramp or changing lanes.
- The vertical force (20% of the cargo weight) represents cargo vibration during transport. This requirement is satisfied when the cargo is "Fully Contained" (see page 1.4).

Note: The securement system must provide a downward force equivalent to at least 20% of the weight of the cargo, if it is not fully contained within the structure of the vehicle.

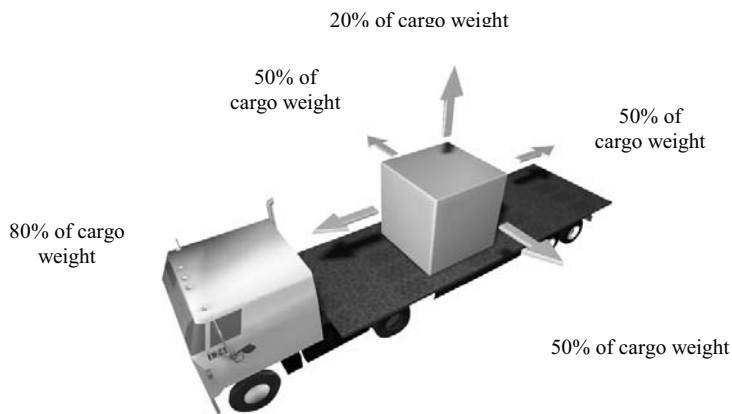

PART I (con't)

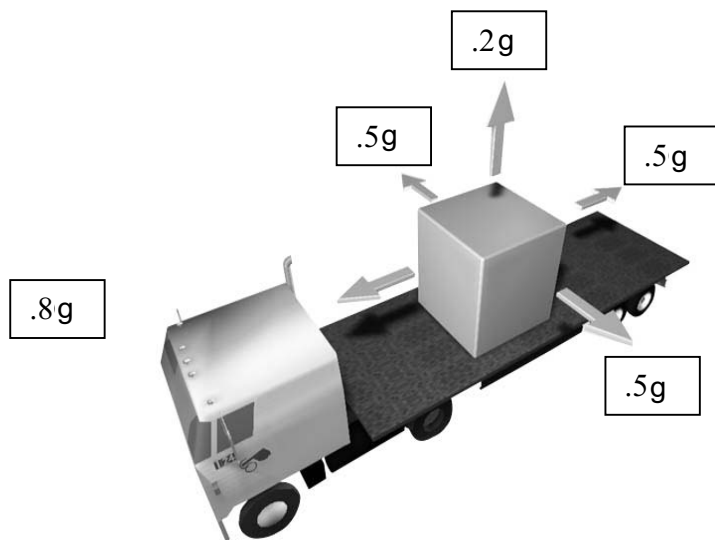

The performance criteria may also be expressed in terms of acceleration, which is shown above (“g” is the term used for gravity, and represents acceleration or deceleration).

- 0.8 g deceleration in the forward direction
- 0.5 g deceleration in the rearward direction
- 0.5 g acceleration in a side-to-side or lateral direction
- 0.2 g vertical acceleration

EXAMPLE: If a steel coil weighs 10,000 lbs., the load securement must provide 8,000 lbs. of securement to prevent movement in the forward direction, which is expressed as 80% of the cargo weight (or 0.8 g).

"Fully Contained" Cargo:

"Fully contained" means that the cargo is placed against a vehicle structure of adequate strength or other cargo so that it cannot shift or tip. Cargo that fills a *sided vehicle* of adequate strength is considered fully contained.

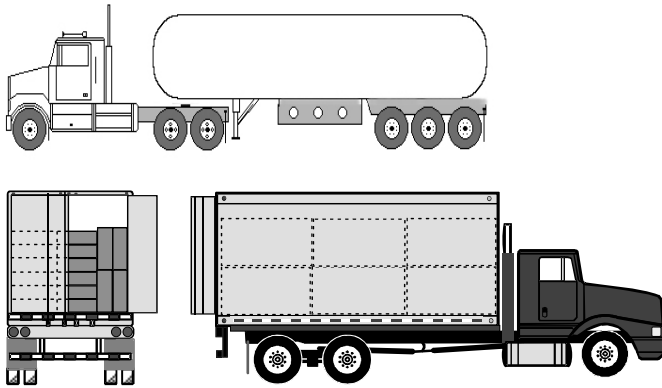

PART II - Performance Criteria for Components of a Securement System

Each component of the cargo securement system should not exceed its *Working Load Limit (WLL)*, when at maximum force. The Working Load Limit is the maximum load that may be applied to a component of a cargo securement system during normal service; it is usually assigned by the manufacturer of the component.



Each force in the performance criteria is to be applied separately to the securement system to determine if it is compliant.

Components of a Securement System

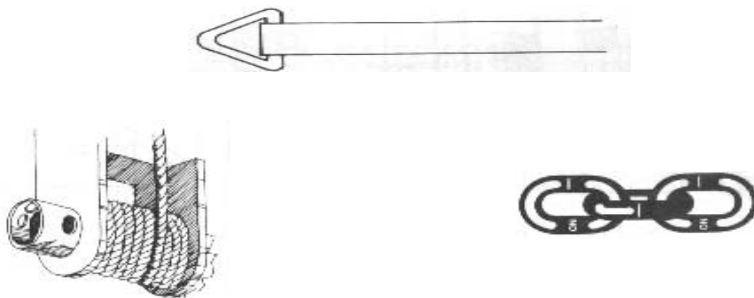

TEST YOUR KNOWLEDGE OF SECTION 1

1. What types of commercial vehicles are required to comply with the cargo securement standard?
2. What is the minimum amount of force that cargo should be expected to withstand when traveling on a curve, ramp or when changing lanes?
3. If an aluminum coil weighs 12,000 lbs., the load securement must provide 6,000 lbs. of securement to prevent movement in the rearward direction. How is this performance criteria expressed in terms of gravity ("g")?
4. The securement system must provide what percentage of the weight of the cargo if it is not fully contained within the structure of the vehicle?
5. What is the definition of Working Load Limit (WLL)?

SECTION 2

GENERAL PROVISIONS AND REQUIREMENTS

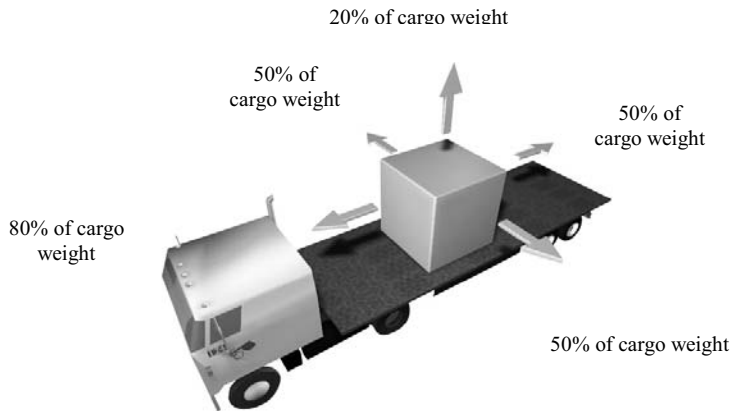

Failure Modes for Securement Systems:

When cargo is subjected to the forces in the performance criteria (Section 1), and when the securement system is not adequate, the system will fail in one of the following three failure modes:

- rolling
- sliding
- tipping

Objectives for Securement Equipment and Devices:

It is the responsibility of drivers, shippers, carriers and enforcement personnel to ensure that all securement equipment, devices and the vehicle structure are in good working order and are used within their capability.

Securement systems are made up of the following categories:

- Category 1- Vehicle Structure and *Anchor Points*, Cargo Securement Responsibility and Cab Shields
- Category 2 - Securement Methods
- Category 3 - Devices, Assemblies and Components
- Category 4 - *Dunnage* Materials

CATEGORY 1

Vehicle Structure and Anchor Points:

The vehicle must be strong enough to resist the forces in the performance criteria (Section 1). The vehicle must be appropriate for the cargo it is to transport, or it must be adapted to be suitable by using fittings, fixtures, dunnage, cribbing or other means.



(Photo courtesy of: Doepker Industries Ltd)

Cargo Securement Responsibility:

According to federal and state regulations, the carrier and driver are responsible for ensuring that the vehicles, anchor points and other securement components are in good working order, with no obvious signs of damage. The driver is also required to conduct a pre-trip inspection by other operating regulations.

Roadside inspections are conducted in accordance with federal, state and provincial laws. If securement equipment fails inspection, it is likely that the vehicle may be placed out-of-service, and the motor carrier and/or the driver may be fined.

Cab Shields:

A cab shield is a safety device mounted to the tractor; it is not a part of the cargo securement system.

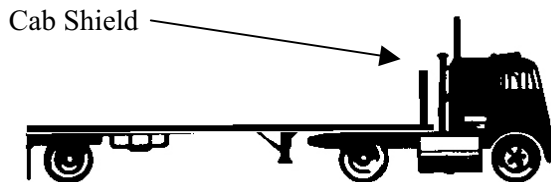

CATEGORY 2

Securement Method:

Because metal coils are different in size, shape, weight and other properties, the shipper and the carrier should devise a securement method that is suited to the characteristics of the cargo, and that meets the performance criteria (Section 1).

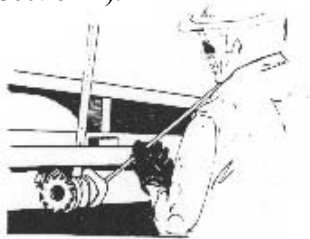

(Illustration courtesy of: Gouvernement du Québec Ministère des Transports)

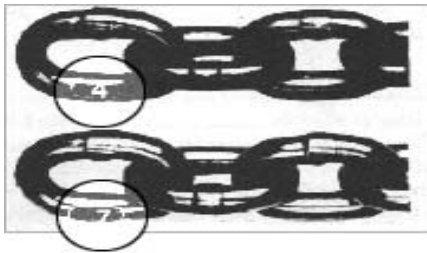

CATEGORY 3

Securement Devices, Assemblies and Components - Packaging:

If a package collapses in transit after the *tiedowns* are tensioned, the tiedowns become loose and parts of the load may fall from the vehicle. Because the shipper usually packages cargo, the shipper needs to make sure that the packages are strong enough to withstand the forces during transport (see the performance criteria in Section 1). After the driver completes an inspection, it is the responsibility of the driver to inform the carrier that the packaging is not adequate.

- All securing devices must be used in accordance with the manufacturer's instructions.
- Where practicable, all tiedowns must be inside of the rub rail.
- Edge protection must be used. The edge protection must resist abrasion, cutting and crushing.
- Tiedowns and securing devices must not contain knots.
- When necessary, tiedowns must be repaired according to applicable standards or the manufacturer's instructions.

Securement Devices, Assemblies and Components - Tiedowns:

A tiedown is made up of a combination of securing devices (that is, an assembly) that restrains cargo on a trailer (or vehicle), and that is attached to anchor points.

There are two types of tiedowns that are used to restrain cargo: direct tiedowns and indirect tiedowns.

- Indirect tiedowns create a downward force that increases the friction between the cargo and the deck. This increased friction restrains the cargo.

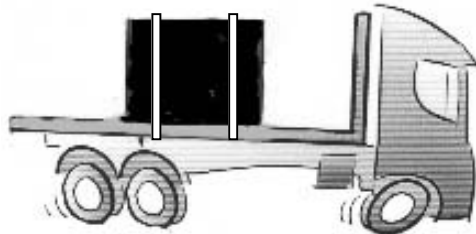

Indirect Tiedowns

- Direct tiedowns provide direct resistance to oppose the forces that are acting on the cargo. This direct resistance keeps the cargo in place, and prevents movement.

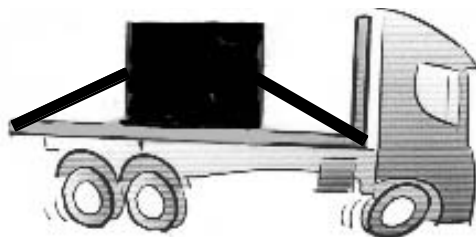

Direct Tiedowns

Responsibility for Tightening Tiedowns:

Tiedowns (except for steel strapping) must be designed, constructed and maintained so they can be tightened by the driver. Each tiedown must be attached and secured so it does not become loose or unfastened while the vehicle is in transit.

Location of Tiedowns:

All tiedown parts must be within the rub rails for platform type vehicles (this does not apply when the load extends beyond the rub rails).

Use of Edge Protection:

Edge protection must be used if a tiedown may be cut or worn. The edge protection itself must also resist crushing, cutting and abrasion. An edge protection device should fit properly on the edge of the article, with no space under the device for it to crush into.

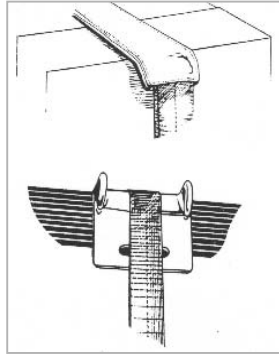

CATEGORY 4

Dunnage Materials:

Timber used between tiedowns and cargo must be strong enough not to split or be crushed.

Any timber used should be properly seasoned, and free of rot or decay. The grain should run lengthwise along the timber when it is used for structural purposes like *blocking* and *bracing*. Timber should be free of knots, knotholes and splits that may affect its strength or interfere with nailing.

General Securement Requirements - Securement Options:

All types of cargo must satisfy one of the following three conditions when being secured:

- fully contained by structures of adequate strength, or

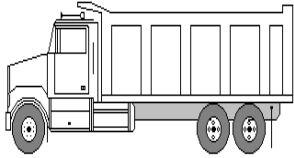

Dump Bodies

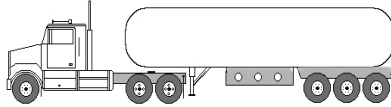

Tankers

- immobilized by structures of adequate strength to prevent shifting or tipping, or

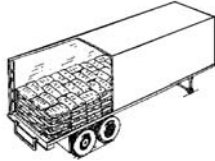

- immobilized on or within a vehicle by appropriate means to prevent shifting or tipping.

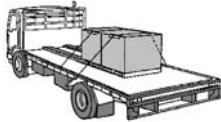

Note: If additional securement is required for a specific commodity (such as metal coils), the specific requirements for securing that commodity take precedence.

Working Load Limit:

The Working Load Limit is the maximum load that may be applied to a component of a cargo securement system during normal service. This value is assigned by the component manufacturer or the default rating in the Working Load Limit Table (see page 2.7).

Note: Welded steel chain that is not marked or labeled with a grade or working load limit, is considered to have a working load limit equal to that for grade 30 proof coil chain.



WORKING LOAD LIMIT (WLL) TABLE



CHAIN WLL IN POUNDS					
Size (inches)	Grade 30 Proof coil	Grade 43 High test	Grade 70 Transport	Grade 80 Alloy	Grade 100 Alloy
1/4	1,300	2,600	3,150	3,500	4,300
5/16	1,900	3,900	4,700	4,500	5,700
3/8	2,650	5,400	6,600	7,100	8,800
7/16	3,700	7,200	8,750		
1/2	4,500	9,200	11,300	12,000	15,000
5/8	6,900	13,000	15,800	18,100	22,600
Chain Mark Examples:					
Example 1	3	4	7	8	10
Example 2	30	43	70	80	100
Example 3	300	430	700	800	1000

Nylon Rope	
Diameter mm (inches)	WLL kg (pounds)
10 (3/8)	130 (278)
11 (7/16)	190 (410)
13 (1/2)	240 (525)
16 (5/8)	420 (935)
20 (3/4)	640 (1,420)
25 (1)	1,140 (2,520)

Double Braided Nylon Rope	
Diameter mm (inches)	WLL kg (pounds)
10 (3/8)	150 (336)
11 (7/16)	230 (502)
13 (1/2)	300 (655)
16 (5/8)	510 (1,130)
20 (3/4)	830 (1,840)
25 (1)	1,470 (3,250)

Steel Strapping	
Width x thickness mm (inches)	WLL kg (pounds)
31.7 x .74 (1-1/4 x 0.029)	540 (1,190)
31.7 x .79 (1-1/4 x 0.031)	540 (1,190)
31.7 x .89 (1-1/4 x 0.035)	540 (1,190)
31.7 x 1.12 (1-1/4 x 0.044)	770 (1,690)
31.7 x 1.27 (1-1/4 x 0.05)	770 (1,690)
31.7 x 1.5 (1-1/4 x 0.057)	870 (1,925)
50.8 x 1.12 (2 x 0.044)	1,200 (2,650)
50.8 x 1.27 (2 x 0.05)	1,200 (2,650)

Wire Rope (6 x 37, Fiber Core)	
Diameter mm (inches)	WLL kg (pounds)
7 (1/4)	640 (1,400)
8 (5/16)	950 (2,100)
10 (3/8)	1,360 (3,000)
11 (7/16)	1,860 (4,100)
13 (1/2)	2,400 (5,300)
16 (5/8)	3,770 (8,300)
20 (3/4)	4,940 (10,900)
22 (7/8)	7,300 (16,100)
25 (1)	9,480 (20,900)

Polypropylene Fiber Rope WLL (3-Strand and 8-Strand Constructions)	
Diameter mm (inches)	WLL kg (pounds)
10 (3/8)	180 (400)
11 (7/16)	240 (525)
13 (1/2)	280 (625)
16 (5/8)	420 (925)
20 (3/4)	580 (1,275)
25 (1)	950 (2,100)

Polyester Fiber Rope WLL (3-Strand and 8-Strand Constructions)	
Diameter mm (inches)	WLL kg (pounds)
10 (3/8)	250 (555)
11 (7/16)	340 (750)
13 (1/2)	440 (960)
16 (5/8)	680 (1,500)
20 (3/4)	850 (1,880)
25 (1)	1,500 (3,300)

Manila Rope	
Diameter mm (inches)	WLL kg (pounds)
10 (3/8)	90 (205)
11 (7/16)	120 (265)
13 (1/2)	150 (315)
16 (5/8)	210 (465)
20 (3/4)	290 (640)
25 (1)	480 (1,050)

Synthetic Webbing	
Width mm (inches)	WLL kg (pounds)
45 (1-3/4)	790 (1,750)
50 (2)	910 (2,000)
75 (3)	1,360 (3,000)
100 (4)	1,810 (4,000)

Strength Rating for Blocking Systems:

The working load limit of all components used to block cargo from forward movement must be 50% (or more) of the weight of the article being blocked.

The most important securement task is to prevent an article from moving forward, and the best way to prevent forward movement is to immobilize the cargo.

This can be done by placing it against a headboard, bulkhead, stakes or other vehicle structure, or against other cargo that is immobilized in that manner. Blocking and bracing can be placed between the article and vehicle structure, other cargo, or a *void-filler*. A “void-filler” is material used to fill a space between articles of cargo and the structure of the vehicle, that has sufficient strength to prevent movement of the articles of cargo (for example, 4 ft. x 4 ft. timbers placed between two adjacent articles of cargo to fill the void).

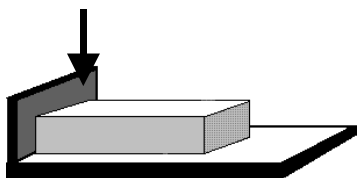

A direct tiedown can also be used to secure cargo against forward movement (see page 2.13)

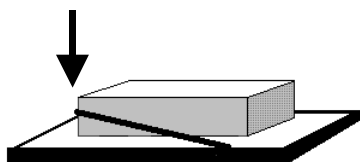

Securement System Strength Rating for Marked Components:

The working load limit of a tiedown is the working load limit of its weakest part, including anchor points (that is, a tiedown is only as strong as its weakest link). In the case of synthetic webbing, the working load limit is the working load limit of the tiedown assembly or the anchor point, whichever is the least.

Some manufacturers mark their manufactured tiedown assemblies, or components, with a numeric Working Load Limit value. In the absence of other information, this value should be used as the working load limit of the component or assembly.

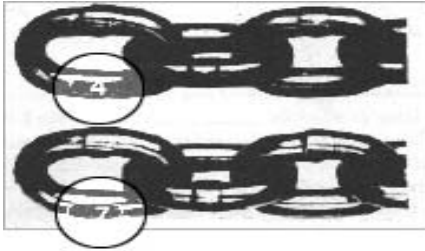

Other manufacturers mark components using a code or symbol that is defined in a recognized standard. For example, a piece of grade 7 chain may be marked with a 7 or 70, in accordance with the standard of the National Association of Chain Manufacturers. The standard then gives the Working Load Limit for that piece of chain, depending on its size.

Securement System Strength Rating for Unmarked Components:

Securement components and assemblies which are not marked are considered to have working load limits as specified in the Working Load Limit Table (see page 2.7).

Note: If markings cannot be read, the tiedown will be considered unmarked.

Carriers should try to purchase and use components that are rated and marked by their manufacturer. That way, the carrier, driver, shipper and inspector can all verify that the proper equipment is being used for the job.

Note: *Friction mats* provide a resistance to horizontal movement equal to 50% of the cargo weight that is resting on the mat.

Cargo Placement and Restraint:

Articles of cargo that are placed beside each other and secured by side-to-side, indirect tiedowns must be either:

- placed in direct contact with each other, or
- prevented from shifting towards each other

Some tiedowns lose their initial tension very quickly in normal driving if there are gaps between articles. Articles must be placed in contact with each other to ensure that there are no gaps, or must be secured by some means to prevent them from moving towards each other in transit. This requirement applies to all layers and stacks of articles that are loaded across a vehicle.

Acceptable Cargo Placement

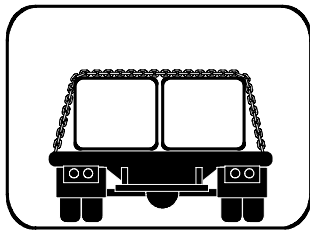

Where two or more long articles (like metal ingots or bundles of reinforcing bars) are loaded lengthwise on a vehicle, if the space between articles cannot be filled with other cargo or blocking, transverse tiedowns can be wrapped around each article to immobilize it against side-to-side movement.

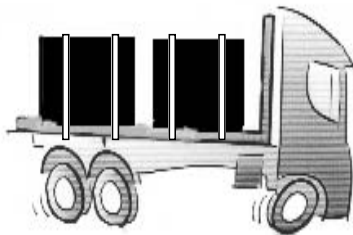

Cargo Roll Prevention

Articles of cargo that have a tendency to roll are difficult to secure. If the article cannot be placed against a vehicle structure of adequate strength, then it must be lifted from the deck and have chocks, wedges, a cradle or some other means to prevent rolling. One of the above must be used to prevent metal coils from rolling.

The method used to prevent rolling must not become unfastened or loose while the vehicle is in transit. For example, the use of timber chocks in coil bunks to form a cradle for metal coils is a reliable way of meeting this requirement. Nailed wood blocking and cleats are a prohibitive means of providing secondary securement for metal coils.

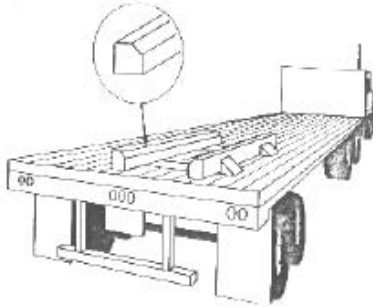

(Illustration courtesy of: Gouvernement du Québec Ministère des Transports)

An article that is resting on the deck, and that is secured on each side by chocks or wedges, may still have a tendency to rock back and forth slightly. Repeated rocking during a trip could cause the securement system to loosen. Supporting a single large or heavy article off the deck will eliminate this tendency.

A cradle is a very effective way to prevent rolling. Cradles that have angles of 45 degrees provide the most restraining force. As the cradle angle decreases from 45 degrees, so does the restraining force.



Where multiple similar articles are placed against each other, the tendency to rock can be controlled if tiedowns through the two end articles pull the articles together, as required for multiple coils.

Aggregate Working Load Limit for Tiedowns:

The sum of the working load limits from all tiedowns must be at least 50% of the weight of the cargo. This applies for both direct and indirect tiedowns.

The manufacturer's working load limit is reduced by 50% for tiedowns which are directly attached from the vehicle to the article, and tiedowns attached to the vehicle that go around, through or over the article and are reattached to the same side of the vehicle. The assumption is that the tiedowns will provide restraint for 50% of the cargo weight in each direction, while friction and other factors provide the additional restraint of up to 30% of the cargo weight in the forward direction (see performance criteria in Section 1).

NOTE: Direct tiedowns, as defined, will have a 50% reduction from the manufacturer's rating or the default rating.

This is the minimum requirement. More tiedown capacity should be used if it is needed to secure an article against any movement. If there is low friction between cargo and the deck (which can be caused by snow, ice, sand, gravel and oil), direct tiedowns or a means to improve friction (for example, friction mats) should be used.

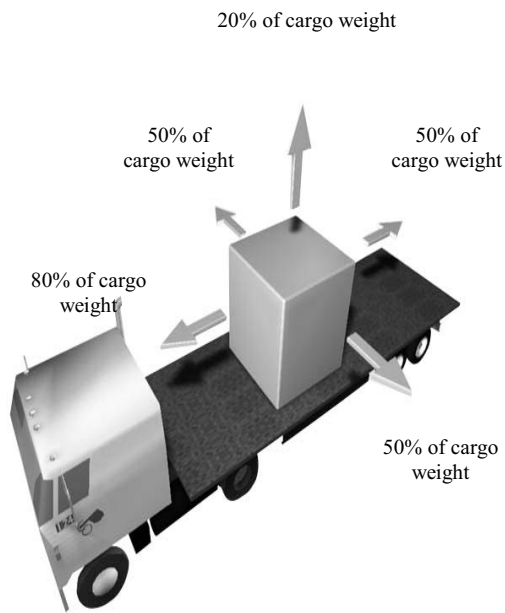

Purpose of Direct Tiedowns:

A direct tiedown resists the performance criteria forces that are applied to the cargo.

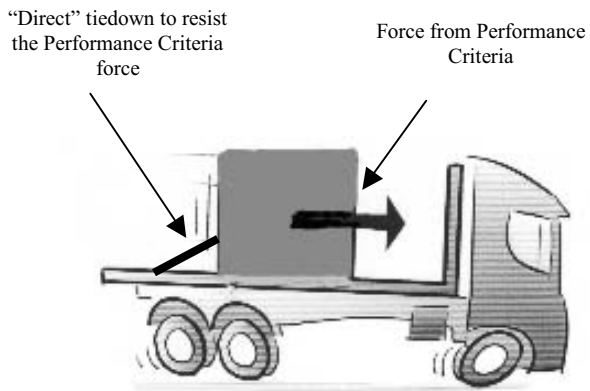

Angles Required When Using Direct Tiedowns:

A direct tiedown is considered effective against forward and rearward forces if it makes an angle less than 45 degrees when viewed from the side of the vehicle.

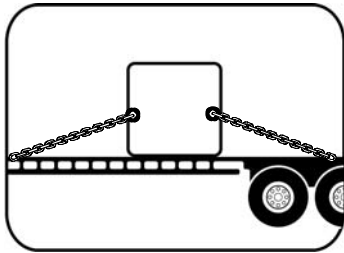

A direct tiedown is considered effective against side-to-side forces if it makes an angle less than 45 degrees with the horizontal when viewed from the front or rear of the vehicle.

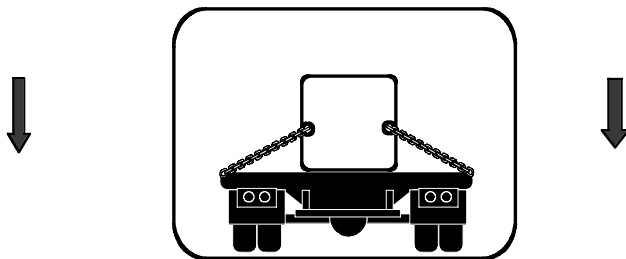

Calculating Working Load Limits for Direct Tiedowns:

When calculating the *aggregate working load limit* of all direct tiedowns count 100% of the tiedown working load limit for each tiedown attached to both sides of the vehicle, as shown in Figure #1, and 50% of the working load limit for each tiedown attached to only one side of the vehicle, as shown in Figure #2. If each tiedown in Figure #1 has a working load limit of 4,000 lbs. (1,820 kgs.), the aggregate working load limit for this securement system is 8,000 lbs. (3,640 kgs.). Each tiedown is connected to the vehicle TWICE. In figure #2, the aggregate working load limit for all tiedowns is 4,000 lbs. (1,820 kgs.).

Figure #1

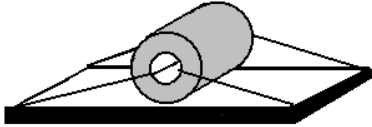
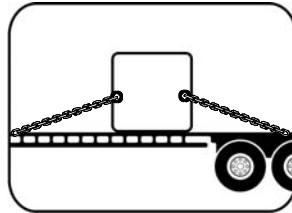
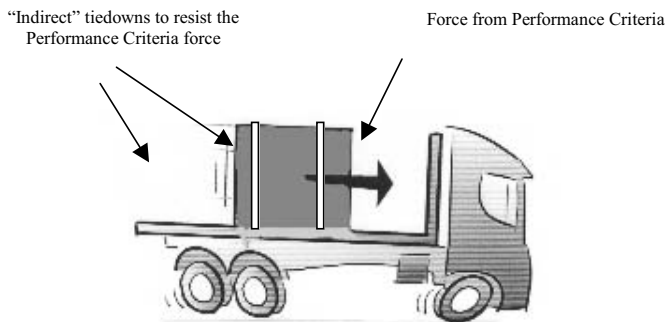

Figure #2



Purpose of Indirect Tiedowns

The purpose of the indirect tiedown is to increase the pressure of the article on the deck (that is, to increase the frictional force between the article and the deck).



An indirect tiedown has failed if the article shifts. If friction is low between the deck and the cargo (such as a plastic skid, plastic-coated article, or an oil-soaked/wet deck), direct tiedowns can be more effective. Under these conditions, consider using friction mats or other friction enhancing devices.

Angles Required for Using Indirect Tiedowns:

An indirect tiedown that is used to prevent front-to-back cargo movement must make an angle of at least 30 degrees with the deck when viewed from the side of the vehicle.

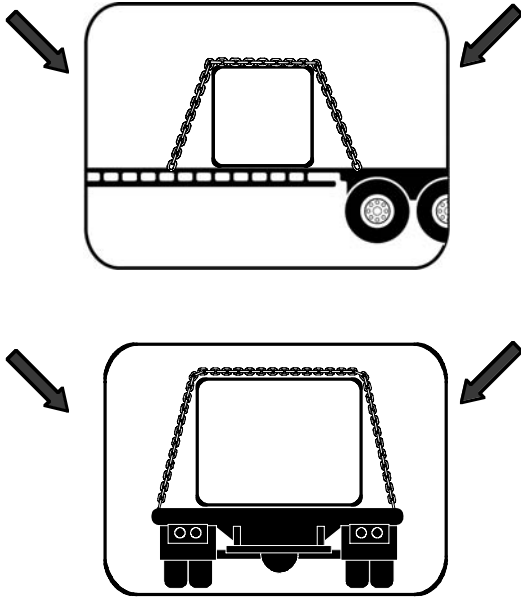

An indirect tiedown that is used to prevent side-to-side movement must make an angle of at least 30 degrees when viewed from the front or back of the vehicle.

An indirect tiedown should be tensioned to as high an initial tension as possible, at least 50% of its working load limit. The tension should be maintained throughout the trip.

Calculating Working Load Limits for Indirect Tiedowns:

Each tiedown that passes over an article is considered to be 1 tiedown.

The aggregate working load limit of all indirect tiedowns is the sum of the working load limits of each indirect tiedown. In this picture, if each tiedown has a working load limit of 4,000 lbs. (1,820 kgs.), the aggregate working load limit for this securement system is 8,000 lbs. (3,640 kgs.).

$$2 \text{ tiedowns} \times 4,000 \text{ lbs.} = 8,000 \text{ lbs.}$$

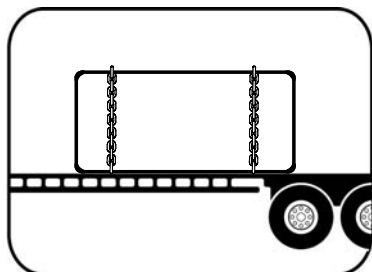

Minimum Number of Indirect Tiedowns Required:

When cargo is **not prevented** from forward movement (by using a headboard, bulkhead, other cargo or direct tiedown), it must be secured using the following requirements [METAL COILS HAVE SPECIFIC REQUIREMENTS]:

Article Description	Minimum Number of Indirect Tiedowns
1.52m (5 ft.) or shorter; 500 kgs. (1,100 lbs.) or lighter	1
1.52m (5 ft.) or shorter; over 500 kgs. (1,100 lbs.)	2
Between 1.52+m (5+ft.) and 3.04m (10 ft.)	2
Longer than 3.04m (10 ft.)	2 + 1 tiedown for every additional 3.04m (10 ft.), or part thereof

When cargo is **prevented** from forward movement (by using a headboard, bulkhead, other cargo or direct tiedown) it must be secured using the following requirements [METAL COILS HAVE SPECIFIC REQUIREMENTS]:

Article Description	Minimum Number of Indirect Tiedowns
All cargo	1 tiedown for every 3.04m (10 ft.), or part thereof

Inspection of Securement Systems:

The driver is responsible for the following cargo securement inspection activities:

Responsibility of Driver	Within first 80 kgs. (50 miles)	When duty status of driver changes	After 3 hrs. or 240 kgs. (150 miles)
Inspect cargo and securing devices	✓	✓	✓
Adjust cargo and/or securing devices	As necessary	As necessary	As necessary
Add additional securing devices	As necessary	As necessary	As necessary

If adjustments need to be made at any inspection, the driver must make them, or must add devices (as necessary) to ensure that the load is properly secured. This means that the vehicle should carry, or be equipped with, additional tiedowns for this purpose.

The driver may be unable to make the inspection if the vehicle is sealed, or if the securement cannot be inspected. There may also be some loads where the driver cannot adjust the securing devices. However, the responsibility for cargo securement still exists, as explained in Section 1. Such loads are still subject to on-highway inspection. If the load is not adequately secured, the driver and/ or carrier could be cited for a violation.

TEST YOUR KNOWLEDGE OF SECTION 2

1. As required by state and federal regulations, who is responsible for proper load securement?
2. A driver is required to check the cargo and its securing devices within how many miles after beginning a trip?
3. What is the working load limit of a binder with a handle marked “3/8-G7, 7/16-G43”?
4. A 5/8-inch chain that has a working load limit of 13,000 lbs. should have links marked with what strength rating?
5. What is the working load limit of unmarked 2-inch synthetic webbing?
6. If a metal coil is secured with 3/8-inch chains that do not display a grade rating, what is the default strength rating assigned to each chain?

SECTION 3 METAL COILS

Preventing Securement Failure:

- Use a securement system to immobilize metal coils to ensure they are prevented from sliding, tipping or rolling.
- Comply with specific securement methods required in regulations.

Application:

Cargo Securement Requirements	Metal Coil(s) and Weight
NYS-CDL DRIVER LICENSE METAL COIL ENDORSEMENT ("M")	Metal coil shipments which weigh 2,268 kgs. (5,000 lbs.) or more, individually or bundled together
ANY COMMERCIAL VEHICLE OR DRIVER	Metal coil shipments which weigh less than 2,268 kgs. (5,000 lbs.), individually or bundled together

The following securement requirements are for metal coils transported on flatbed vehicles, van-type vehicles or intermodal containers that have anchor points. Securement requirements for sided vehicles or intermodal containers without anchor points are covered at the end of this section.

Securement Requirements for a Single Metal Coil with Eyes Vertical:

If the coil is fastened to a pallet, the pallet must be strong enough so it cannot collapse under the forces described in the performance criteria (Section 1).

Tiedowns must be arranged in the following manner to prevent the coils from tipping in the forward, rearward and side-to-side (lateral) directions:

- at least one indirect tiedown attached diagonally from the left side of the vehicle, across the eye of the coil, to the right side of the vehicle;
- at least one indirect tiedown attached diagonally from the right side of the vehicle, across the eye of the coil, to the left side of the vehicle;
- at least one indirect tiedown attached side-to-side over the eye of the coil;
- either blocking and bracing, friction mats or direct tiedowns must be used to prevent forward - rearward movement.

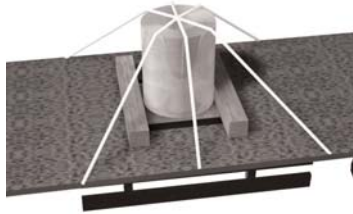

Note: Use a friction mat under the pallet to increase the friction between the pallet and the deck.

The coil should be secured to the pallet to withstand all the forces in the performance criteria (Section 1).

The sum of the working load limits from all tiedowns must be at least 50% of the weight of the coils.

Securement Requirements for a Row of Metal Coils with Eyes Vertical:

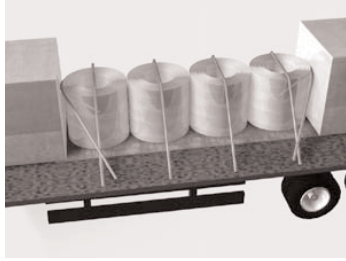

Coils that are transported in rows must be secured by:

- at least one direct tiedown against the front of the row of coils, restraining against forward motion, and if practicable, making an angle 45 degrees or less with the floor.
- at least one direct tiedown against the rear of the row of coils, restraining against rearward motion, and if practicable, making an angle 45 degrees or less with the floor.
- at least one indirect tiedown over the top of each coil or side-by-side row of coils, restraining against vertical motion. Indirect tiedowns going over the top of a coil must be as close as possible to the eye of the coil.
- direct tiedowns, blocking or bracing must be arranged to prevent shifting or tipping in all directions.

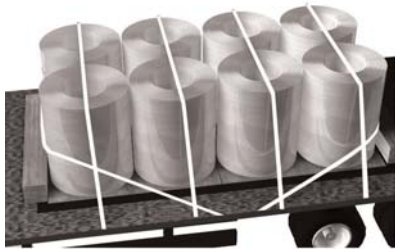

Note: If there are more than two coils in the front and rear rows, the direct tiedown must run outside some kind of channel that bears against all coils in these rows.

Use a friction mat under each pallet to increase the friction between the pallet and the deck. This should always be done when the deck or coil is soaked with oil.

Securement Requirements for Metal Coils With Eyes Crosswise:

Step #1: Support the Coil

To prevent rocking, the coil must be supported above the deck.

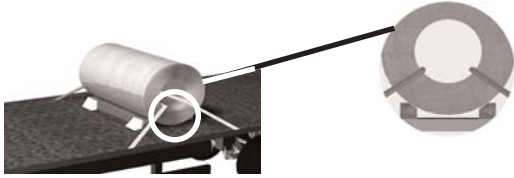

The coil supports must be held in place so they do not become loose during a trip.

If timbers, chocks or wedges are used, they must be held in place by coil bunks or similar devices to prevent them from coming loose.

The use of nailed blocking or cleats as the sole means to secure timbers, chocks or wedges, or a nailed wood cradle, is prohibited.

The cradle can be restrained against sliding by placing friction mats under the timbers and coil bunks, using nailed wood blocking or cleats against the front timber, or by placing a direct tiedown around the front of the cradle.

If a direct tiedown is used around the front of the cradle, it does not count towards the aggregate working load limit for tiedowns through the eye of the coil.

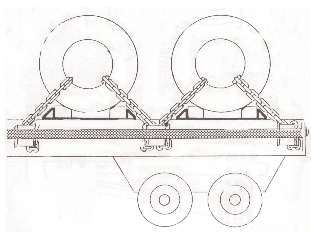

Step #2: Prevent the Coil from Forward Movement

At least one direct tiedown is required through its eye, restricting forward motion.

Step #3: Prevent the Coil from Rearward Movement:

At least one direct tiedown is required through its eye, restricting rearward motion.

If more than two chains are required, they should be placed symmetrically on either side of the coil. If an odd number of chains are required, the last chain should be to the rear.

Attaching direct tiedowns diagonally through the eye of a coil to form an X-pattern when viewed from above the vehicle is prohibited.

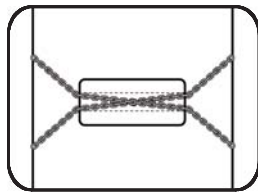

Securement Requirements for Individual Metal Coils with Eyes Lengthwise:

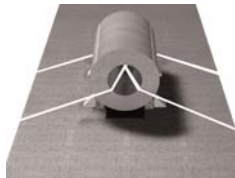

There are three options for safely securing individual coils that are loaded with their eyes lengthwise.

Securement Option #1:

Step #1: Support the coil above the deck to prevent the coil from rolling.



Option #1:

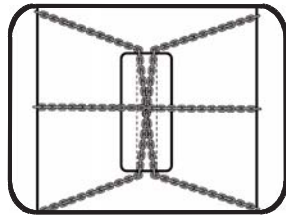

Step #2: Attach at least one direct tiedown on each diagonal through the eye of the coil making an angle not more than 45 degrees with the floor of the vehicle when viewed from the side.

Step #3: Attach at least one indirect tiedown side-to-side over the top of the coil.

Step #4: Use blocking or friction mats to prevent forward movement.



Securement Option #2:

Same as Option #1, except the direct tiedowns are straight instead of diagonal.

Option #1

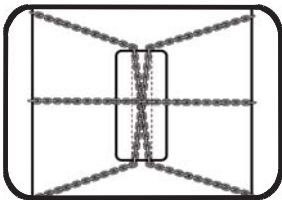

Option #2

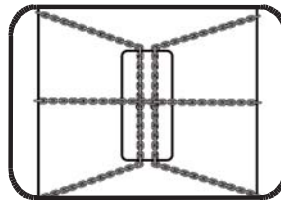

Securement Option #3:

This option is the same as Option #1 and #2, except the two direct tiedowns are replaced with two indirect tiedowns over the front and rear parts of the coil.

Option #3

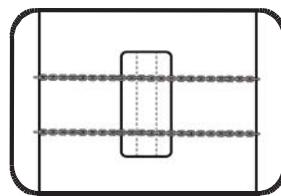

Securement Requirements for a Row of Metal Coils with Eyes Lengthwise:

A row of coils is made up of three or more coils loaded in like mode and in a line. The requirements for securing a row of coils is similar to securing individual coils (Option #3).

Step #1: Support the coils above the deck to prevent the coils from rolling. The means to support the coils (for example, timbers, chocks or wedges, a cradle, etc.) must not become unfastened or loose while the vehicle is in transit.



Step #2: Attach at least two direct tiedowns over each coil or side-by-side row.



Step #3: Use blocking or friction mats to prevent front-to-back movement in the forward direction.



Securement Requirements for Metal Coils in *Sided Vehicles* or Intermodal Containers without Anchor Points:

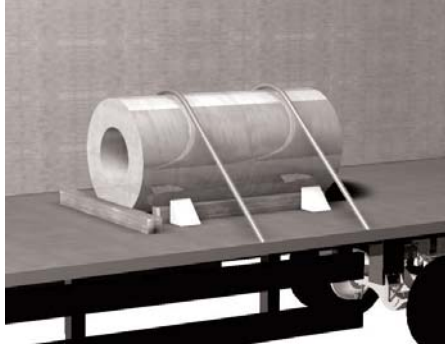

Coils must be prevented from horizontal movement or from tipping, by use of the following:

- friction mats
- system of blocking and bracing
- tiedowns and blocking
- tiedowns and bracing

The carrier/driver must ensure that the securement system meets the performance criteria requirements (Section 1).

TEST YOUR KNOWLEDGE OF SECTION 3

1. Transportation of one or more metal coils (individually or bundled together) weighing 5,000 lbs. or more, must comply with which load securement requirement?
2. How are tiedowns used to secure coils transported with eyes vertical on a flatbed vehicle, in a sided vehicle or intermodal container with anchor points?
3. What structure or device is used to prevent longitudinal movement of the coil in the forward direction?
4. Which means of securement is prohibited when transporting coils with the coil eye crosswise on the vehicle?
5. The sum of the working load limits (WWL) from all tiedowns must be at least what percentage of the weight of the coils?
6. When is use of a friction mat recommended?
7. What are the requirements for securing metal coils with eyes lengthwise?

DEFINITIONS

Aggregate working load limit - The aggregate working load limit is the sum of:

1. One-half the working load limit of each tiedown that goes from an anchor point on the vehicle to an anchor point on an article of cargo;
2. One-half the working load limit of each tiedown that is attached to an anchor point on the vehicle, passes through, over, or around the article of cargo, and is then attached to an anchor point on the same side of the vehicle;
3. The working load limit for each tiedown that goes from an anchor point on the vehicle, through, over, or around the article of cargo, and then attaches to another anchor point on the other side of the vehicle.

Anchor point - Part of the structure, fitting or attachment on a vehicle or article of cargo to which a tiedown is attached.

Article of cargo - A unit of cargo, other than a liquid or gaseous cargo, that includes articles grouped together so they can be handled as a single unit or can be grouped together by wrapping, strapping, banding or edge protection device(s).

Blocking - A structure, device or another substantial article placed against or around an article of cargo to prevent horizontal movement of the article of cargo.

Bracing - A structure, device, or another substantial article placed against an article of cargo to prevent it from tipping, that may also prevent it from shifting.

Dunnage - All loose materials used to support and protect cargo.

Edge protector - A device placed on the exposed edge of an article to distribute tiedown forces over a larger area of cargo than the tiedown itself, to protect the tie-down and/or cargo from damage, and to allow the tiedown to slide freely when being tensioned.

Friction mat - A device placed between the deck of a vehicle and an article of cargo, or between articles of cargo, intended to provide greater friction than exists naturally between these surfaces.

"g " - The acceleration due to gravity, 32.2 ft/sec² (9.823 m/sec²).

Metal Coil - A product comprised of mixtures, compounds and/or alloys commonly known as metal, metal foil, metal leaf, forged metal, stamped metal, metal wire or metal chain that are generally good conductors of electricity and heat, and that can be melted or fused, hammered into thin sheets, or drawn into wire, that are bulk packaged or packaged from a continuous pull or multiple pulls as a roll, coil, spool, wind or wrap.

Sided vehicle - A vehicle whose cargo compartment is enclosed on all four sides by walls of sufficient strength to contain articles of cargo, where the walls may include latched openings for loading and unloading. Includes vans, dump bodies, and a sided internodal container carried by a vehicle.

Tiedown - A combination of securing devices which forms an assembly that attaches articles of cargo to, or restrains articles of cargo on, a vehicle or trailer, and is attached to anchor point(s).

Tractor-pole trailer - A combination vehicle that carries logs lengthwise so they form the body of the vehicle. The logs are supported by a bunk located on the rear of the tractor, and another bunk on the skeletal trailer. The tractor bunk may rotate about a vertical axis, and the trailer may have a fixed, scoping or cabled reach, or other mechanical freedom, to allow it to turn.

Void filler - Material used to fill a space between articles of cargo and the structure of the vehicle, that has sufficient strength to prevent movement of the articles of cargo.

Working load limit (WLL) - The maximum load that may be applied to a component of a cargo securement system during normal service, usually assigned by the manufacturer of the component.

ACKNOWLEDGMENTS

The NYS Department of Motor Vehicles wishes to thank the staff of the NYS Department of Transportation and the Canadian Council of Motor Transport Administrators (CCMTA) who contributed their time and expertise to the North American Metal Coil Cargo Securement Program, on which the materials in this manual are based.



NEW YORK STATE DEPARTMENT OF MOTOR VEHICLES

David A. Paterson
Governor

David J. Swarts
Commissioner